

HRT-LF(DC/3000)-03S--- Lowpass Filter

Electrical Specifications			Product Picture
Parameter	Unit	Specification	
Frequency Range:	MHz	DC-3000	
Insertion Loss:	dB	Max 1.0	
Ripple:	dB	Max TBD	
VSWR:	/	Max 1.7:1	
Power Handling:	5W CW max		
Rejection:	≥50dB@3800-8000MHz		
Mechanical Specifications		Environmental Specification	
Parameter	Specification	Parameter	Specification
Input Connector:	SMA-Female(50Ω)	Operating Temp.	-40°C to +70°C
Output Connector:	SMA-Female(50Ω)	Storage Temp.	-55°C to +85°C
Size(mm):	43*27*14	Environment Class:	TBD
ROHS:	Yes	Altitude:	60,000 ft. 1.0psi min (Hermetically Sealed Un-controlled environment)(Optional)
Material:	Aluminium		
Weight(Kg):	TBD	Humidity:	95%RH at 40°C
Surface Finish:	Black painted	Shock:	20G for 11msec half sine wave,3 axis both directions
Note:			

Configuration :

All Dimensions in mm (inches)

Outline Tolerances ±0.3(0.012)

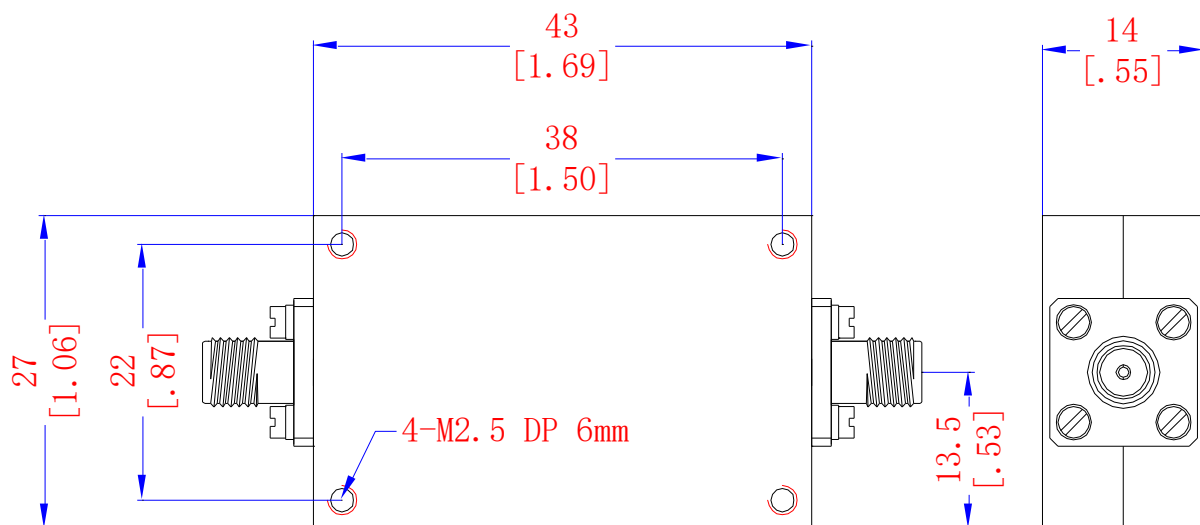

E5063A Network Analyzer

1 Active Ch/Trace 2 Response 3 Stimulus 4 Mkr/Analysis 5 Instr State

Resize

